

KINOVA®
Jaco®
assistive robot

TAKE CONTROL
AND MOVE
MORE EASILY



USER GUIDE

Contents

Disclaimer.....	1
About this document.....	2
Symbols, definitions, and acronyms.....	3
Warranty.....	6
Safety / warnings.....	8
Jaco robotic arm.....	11
General information.....	11
Components.....	11
Robot external connectors.....	11
Specifications.....	12
Robot control modes.....	13
Home / retract positions.....	15
Installation, configuration, and operation of the robot.....	15
Normal use definition.....	16
Electromagnetic interference from radio wave sources.....	17
Operating and controlling the robot.....	18
Kinova joystick controller.....	19
Packing materials.....	28
OLED display accessory.....	29
OLED: General information.....	29
Dimensions.....	29
Identification of parts.....	29
Specifications.....	31
Installation guidelines.....	31
Connecting the display.....	32
The OLED display.....	34
Precautions.....	34

Power-up sequence.....	34
Screen sections.....	36
Movements display.....	43
Sleep mode.....	45
Major errors.....	45
Joystick and communication error.....	45
Communication Lost error.....	46
Lift arm accessory.....	47
Lift arm: General information.....	47
Lift arm specifications.....	49
Lift arm components.....	49
Lift arm limit switch.....	51
Controlling tilt back / forward control.....	52
Using the swing-away mechanism.....	53
Cleaning, maintenance, and disposal.....	55
Contacting support.....	58

Disclaimer

Kinova®, Kinova OLED display, and the Kinova logo are trademarks of Kinova inc., herein referred to as Kinova. All other brand and product names are trademarks or registered trademarks of their respective corporations.

The mention of any product does not constitute an endorsement by Kinova. This manual is furnished under a lease agreement and may only be copied or used within accordance with the terms of such lease agreement. Except as permitted by such lease agreement, no part of this publication may be reproduced, stored in any retrieval system, or transmitted, in any form or by any means, electronic, mechanical, recording, or otherwise, without prior written consent of Kinova.

The content of this manual is furnished for informational use only, is subject to change without notice, and should not be construed as a commitment by Kinova. Kinova assumes no responsibility or liability for any errors or inaccuracies that may appear in this document.

Changes are periodically made to the information herein; these changes will be incorporated into new editions of this publication. Kinova may make improvements and/or changes in the products and/or software programs described in this publication at any time.

Address any questions or comments concerning this document, the information it contains or the product it describes through the Kinova website support page:

www.kinovarobotics.com/support

Kinova may use or distribute whatever information you supply in any way it believes appropriate without incurring any obligations to you.

About this document

This document contains information on the installation and operation of the Jaco® assistive robotic arm, as well as its accessories, the OLED display (PD 0508 0001) and the Lift Arm.

 Read all instructions before using this product.

 Read all warnings on the product and in this guide.

 Follow all instructions.

 Keep these instructions for future reference.

This document contains information regarding product setup and operation. It is intended for:

- Kinova product end users
- Field service, customer support and sales employees of authorized Kinova distributors

Symbols, definitions, and acronyms

Throughout the manual, icons are used to draw the reader's attention. Each icon or symbol is explained.



Important information regarding the safety related to the product and the user



Warning: Safety measure that could lead to injury if ignored



Tip on the maintenance, operation and manipulation of Kinova's products



Notice: General important information and good practice



Caution: Safety measure that could lead to equipment damage if ignored



Refer to accompanying documents



Pinch point



Medical device



Serial number



Date of manufacturing



Manufacturer

Kinova inc.
4333 boulevard de la Grande-Allée
Boisbriand, Québec J7H 1M7



Direct current



Alternating current



Operating temperature range



Compliance with WEEE2 directive; Waste electrical and electronic equipment



Compliance with ROHS 3² directive; Restriction of hazardous substances



Type BF Applied Part device



European Union (EU) mandatory conformity marking



European Union (EU) Authorized Representative:

CEpartner4U BV
 Esdoornlaan 13
 3951 DB Maarn
 The Netherlands



UK Authorized Representative:

UKCApartner4U
 7 Campion Way,
 Bingham,
 Nottingham NG13 8TR, UK

Contact

Mr Simon Keightley
 Mrs Rogier Nusselder

Email

office@UKCApartner4U.co.uk



KS Swiss Authorized Representative:

SKS Rehab AG
IM Wyden 3
CH-8762 Schwanden

Telephone	+41 55 647 35 85
Email	sks@sks-rehab.ch
SRN – Number	CHRN-IM-20000882

Kinova assumes no liability of any kind if safety measures are not followed. Please read all the information concerning this product before using it.

This document is addressed to Kinova’s authorized, certified partners, distributors and end users.

Warranty

This section describes the warranty terms of Kinova inc.

Subject to the terms of this clause, Kinova inc., warrants to End User that the Products are free of defects in materials and workmanship that materially affect their performance for a period of two (2) years from the date Kinova ships the Products to the End User ("Delivery Date"). The exception of this warranty is the Lift arm, which has a 1 year protection against defects in materials or workmanship.

Kinova agrees to repair or replace (at Kinova's option) all Products that fail to conform to the relevant warranty provided that:

1. Notification of the defect is received by Kinova within the warranty period specified above.
2. Allegedly defective Products are returned to Kinova, at the End User's expense, with Kinova's prior authorization within thirty (30) days of the defect becoming apparent.
3. The Products have not been altered, modified or subject to misuse, incorrect installation, maintenance, neglect, accident or damage by excessive current or used with incompatible parts
4. The End User is not in default under any of its obligations under this Agreement.
5. Replacement Products must have the benefit of the applicable warranty for the remainder of the applicable warranty period.

If Kinova diligently repairs or replace the Products in accordance with this section, it will have no further liability for a breach of the relevant warranty.

Allegedly defective Products returned to Kinova in accordance with this contract will, if found by Kinova on examination not to be defective, be returned to End User and Kinova may a charge a fee for examination and testing.

The warranty cannot be assigned or transferred and is to the sole benefit of the End User.

Where the Products have been manufactured and supplied to Kinova by a third party, any warranty granted to Kinova in respect of the Products may be passed on to the End User.

Kinova is entitled in its absolute discretion to refund the price of the defective Products in the event that such price has already been paid.

Warranty claims shall be voided if:











- Conditions specified in the user manual are ignored.
- The device is used outside the normal use definition.
- Any part of the appliance is modified or opened.

- Repairs or replacements are carried out by anyone other than a certified and approved professional.

Safety / warnings

Follow basic safety rules when working with the Jaco, OLED display, and Lift Arm to avoid injury or damage to the equipment.

Jaco and OLED display considerations

-  It is not recommended to use the robot under heavy rain or snow.
-  Be careful not to hit the robot on a doorframe. The impact could damage the inner components or break the frame of the robot, which would create an electrical shock hazard. Always ensure there is sufficient space for the robot to go through the door; also ensure the door cannot close on the robot.
-  Never use the Home / Retract function when carrying liquid. The home position is preset and the wrist may rotate and drop the liquid.
-  Do not manipulate cutting, very sharp or any dangerous tools or objects with the robot.
-  When the power is turned off, the robot will fall down and may cause damage to itself, depending on its position at the time of disconnection. Be sure to support its wrist before turning the power off.
-  Do not force the fingers beyond their maximal opening. This could damage some internal components.
-  Do not immerse any part of the robot under water or snow.
-  When lifting weight near the maximum load and reach, and you receive a warning, put down the object in the gripper, bring the robot back to the Home or Retract position and wait until the warning goes away before using it again.
-  The wheelchair mode (wheelchair / seat motorization / arm) must never be switched while operating the robot. There is a risk of user contact with the moving robot associated with switching the mode during operation.
-  Do not block the robot movement when it is performing a Retract position trajectory.
-  Any adjustment (mechanical, electrical or programming) done to a wheelchair already equipped with a robotic arm may have a critical impact on the robot functionality or safety.

Always instruct the personnel or company that will be responsible for servicing your wheelchair to contact the local Kinova representative before doing any changes.

 When reinstalling Jaco at home, verify the retract position is still properly adjusted; that is, make sure the robot gripper, and elbow if possible, is resting on some fixed part of the wheelchair, so that the motor power is used minimally to maintain this position. Contact Kinova Support if the retract position needs to be adjusted.

Lift arm considerations

 The lift arm should only be installed by a trained and certified Kinova-approved professional.

 No parts should be repaired or replaced by the end user. If any problem with the device occurs, repairs are to be made only by a Kinova-certified technician.

 Do not open the internal mechanisms of the lift arm or lift arm controller. This should only be performed by the manufacturer. Opening the lift mechanism will void the warranty and could result in improper functioning of the device that endangers the user.

 If the device is not responding properly to controls, do not use the device until it has been verified by a trained and certified technician. Contact Kinova support for more details.

 After using the lift arm, you need to allow time for the electromechanical actuator inside the unit to cool down properly before using the lift arm again. Allow 10 minutes of rest after each minute of use. The maximum period of continuous use should not exceed 2 minutes. Failure to follow these limits may result in damage to the lift arm mechanism.

 The software in the Kinova arm that governs the protection zones around the user and the defined trajectories of the arm assumes that the base of the arm is stationary in relation to the wheelchair and user. The software **does not take into account** the tilt movements of the lift arm. Be cautious and attentive when using the robotic arm with the lift arm lowered, to avoid collisions between the arm and your body and/or the wheelchair.

 Ensure when lowering the lift arm that the gripper on the end of the robotic arm does not make contact with the floor or ground.

 The arm still holds up the full weight of any object, so attempting to lift a heavier object may cause damage to the robotic arm or the lift arm. Such damage would fall outside the limitations of the warranty.

 Do not use the lift arm in heavy rain or snow. Do not immerse it in water or other liquids. Wipe off the device after exposure to water or liquids.

 Do not use the robotic arm or tilt the lift arm when the swing-away mechanism is engaged.

 The swing-away action of the lift arm should only be activated when the wheelchair is stationary. Do not move the wheelchair while the lift arm is swung out to the side. There is a risk of the arm hitting an object and damaging the robotic arm or lift arm. Be cautious when driving the wheelchair forward while the lift arm is lowered and the gripper of the robotic arm is close to the floor / ground. Driving the wheelchair while the robotic arm is in contact with the floor / ground could damage the robotic arm or the lift arm and /or cause serious injury.

 When the lift arm is swung out to the side, do not apply extra weight on the robotic arm and lift arm. This will put stress on the mounting connectors attaching the lift arm to the wheelchair, as well as to the mounting rail of the wheelchair.

 Make sure that the swing-away mechanism is latched and that the lift arm is level when passing through narrow areas. This includes, but is not limited to, doorways, narrow hallways, or aisles in shops.



The lift arm has potential pinch points. These are labeled on the lift arm. The risk is low for users, but you should ensure that bystanders, particularly children, have their fingers clear of the lift mechanism before engaging the lift arm.

 Buttons should not be disconnected from the lift arm controller except by a Kinova-approved professional.

 The limit switch should only be adjusted by a Kinova-approved professional.

Jaco robotic arm

General information

Jaco is a medical device intended to be used on wheelchairs for people with functional limitations or upper body disabilities. The robot is designed to support in eating and drinking tasks, personal hygiene, medication management, leisure and active life, work, school, and personal safety.

The Jaco is a light-weight robot composed of six inter-linked segments. Through the controller, the user can move the robot in three-dimensional space and grasp or release objects with the gripper.

⚠ Do not modify equipment without the authorization of the manufacturer.

⚠ It is not recommended to use the arm under heavy rain or snow.

Components

This section shows the components of the robot.

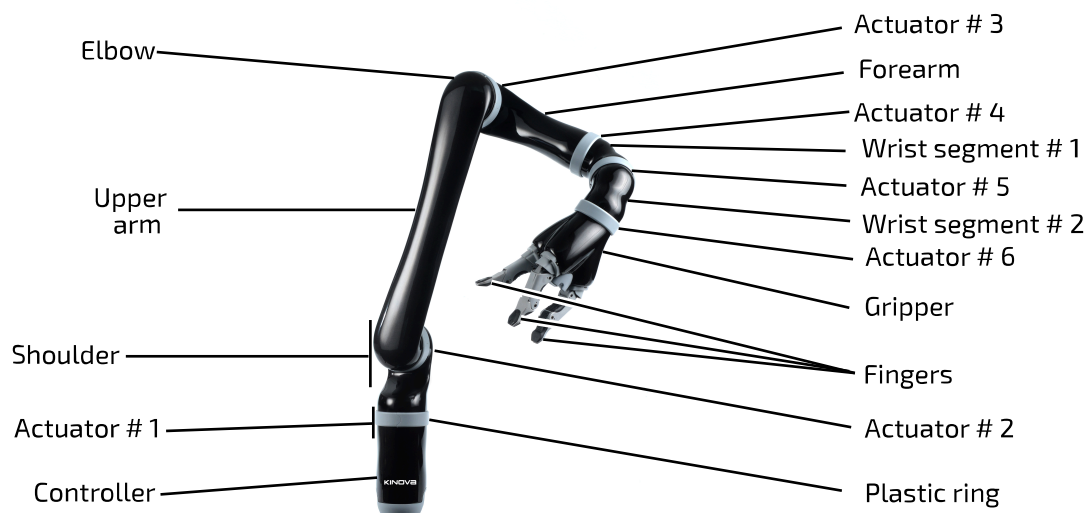

Figure 1: Robot components

Robot external connectors

This section describes the external connectors on the base of the robot.

The following figure shows the external connectors located on the base of the robot.

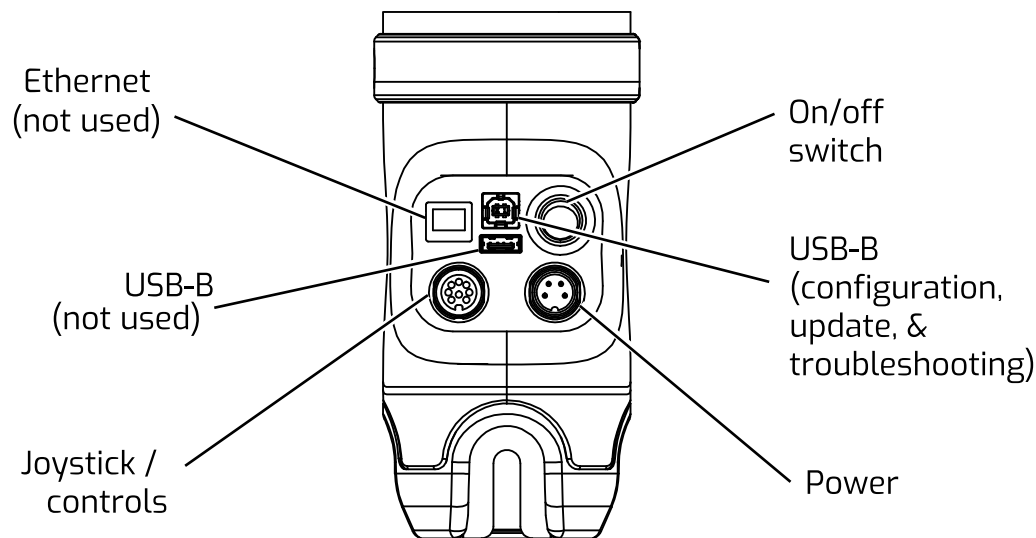

Figure 2: Robot external connectors

The panel at the back of the base has several connectors and a power on / off switch.

The **power on/off switch** is used to power up or power down the robotic arm.

The four-pin **power connector** is used to connect the robotic arm to electrical power.

The eight-pin **joystick / controls / expansion port** is used to connect the Kinova Joystick or the Universal Interface Control Box for the arm.

The **USB port** is used to connect a computer for maintenance and configuration purposes.

⚠ The control port and power connector are intended to be connected only with a Kinova-approved device. Connecting other devices may result in poor performance, electrical shock, or fire; it could also make the arm inoperable and void your warranty.

⚠ To prevent risk of fire or electric shock, avoid using extension cords.

⚠ Protect the cords from being walked on or pinched.

Specifications

This section describes the specifications of Jaco.

Table 1: Specifications

Total weight	5.4 kg with 3 finger gripper
--------------	------------------------------

Reach	90 cm
Maximum payload	1.6 kg (mid-range continuous)
	1.3 kg (full-reach peak / temporary)
Materials	Carbon fiber (links), Aluminum (actuators)
Joint range (software limitation)	± 27.7 turns
Maximum linear robot speed	20 cm / s
Power supply voltage	24 VDC
Average power	25 W (5 W in standby)
Peak power	100W
Water resistance	IPX2
Operating temperature	-10 °C to 40 °C
Operating humidity (no condensation)	15% to 90%
Operating environment	Do not use in corrosive environment
Gripper force	3 fingers: 40N
Expected life span	5 years

Robot control modes

This section describes control modes for the robot.

The control of the robot is said to be Cartesian as the user only controls movements of the robot hand. The different joints are piloted automatically following the given command. The robot is capable of different movements which may be divided into four control modes:

- translation mode
- wrist mode
- drinking mode
- finger mode

In **translation mode**, the user controls the position of the hand in space. The hand will always keep its parallelism to the wheelchair seat frame. The possible movements are left/right, front/back, and up/down of the hand.

In **wrist mode**, the user controls the position of the arm around the center point of the hand (reference point) which will not move (or move slightly) when operating this mode. Lateral orientation refers to a thumb/index circular movement of the wrist around the reference point.

Vertical orientation refers to a top/bottom circular movement of the wrist around the reference point. Wrist rotation refers to a circular movement of the hand around itself.



Drinking mode is to be used with the wrist rotation only. While operating the robot in drinking mode, the reference point (normally set in the middle of the hand), is offset in height and length to produce a rotation that will compensate when user drinks from a glass or bottle without a straw.

In **finger mode**, the user controls the opening and closing of two or three fingers.

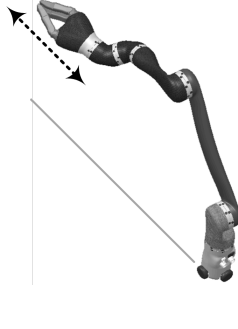
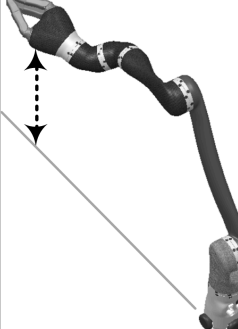
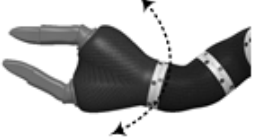
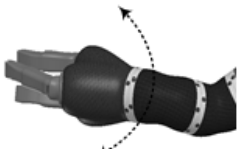

Note: The robot will sometimes respond differently to a given command than described in this section. This may be due to the singularity (impossible robot position) avoidance algorithms embedded in the kinematics. It is a normal protective behaviour of the robot and is position dependent.

Table 2: Robot control modes

Translation mode		
Left / right	Front / back	Up / down
		
Wrist mode		
Lateral orientation	Vertical orientation	Wrist rotation
		
Finger mode		

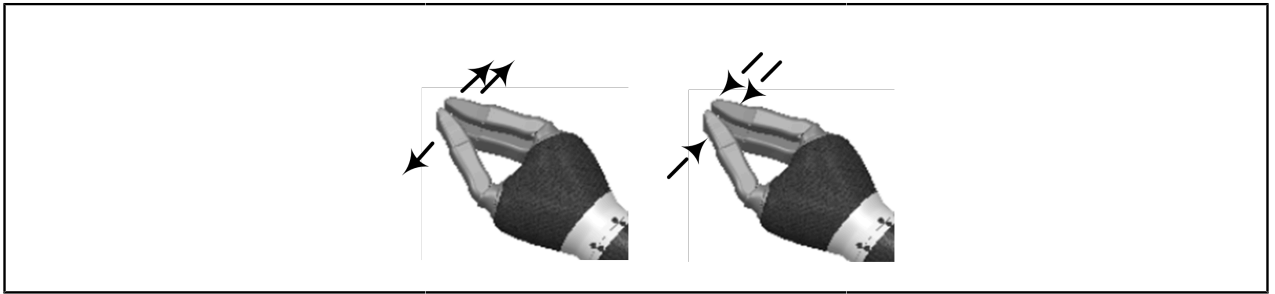

Home / retract positions

This section describes the Home and Retracted positions of the robotic robot.

The robot comes with two configurable factory default pre-set positions:

- Home position and
- Retract position.

Home and retract positions are configured using the *Kinova Assistive Robotic Arm Configurator* utility.

The Home position refers to the position of the robot when it is ready to be used. In the Home position, the robot is awaiting commands from a control device.

The Retract position refers to the position of the robot when it is not used. The user should always place the robot in the Retract position when it is unused as it decreases the physical volume occupied by the robot. In the Retract position, the robot is in standby mode; control device features are disabled and power consumption is much lower.

 Never use the Home / Retract function when carrying liquid. The Home and Retract positions are pre-set and if the wrist rotates, it may spill some liquid.

Installation, configuration, and operation of the robot

A qualified technician certified by Kinova installs the robot by following the instructions in the Installation Guide. Contact Kinova directly to validate whether your contact is a technician approved by Kinova.

When your robot arrives, a Kinova approved installer will help you to get set up and started with your robot. This includes:

- Physical installation of the robot on your powered wheelchair and integration with the wheelchair power supply and controls

- Configuration of the robot using the *Kinova Assistive Robotic Arm Configurator* utility. This includes:
 - Configuring safety settings for the robot, including speed limits and no-go zones around your body
 - Mapping controls of the robot to the wheelchair controller
 - Setting up home and retract positions

The process may take several hours and the installer will make sure that the robot installation is customized to the specifics of your equipment and needs.

The details of how to operate the robot in different modes of control and how to activate these controls will depend heavily on the specific controls available with your wheelchair setup. The details are beyond the scope of this user guide.

You will be provided with training during the installation and configuration process on how to move and operate the robot to perform various tasks.

Normal use definition

The Normal Use definition contains some information fundamental to the proper operation of the robotic arm.

Use only approved accessories with Jaco. For a list of compatible wheelchairs and approved Jaco accessories, please contact your Kinova representative.

Normal use of the robot means that you can lift, push, pull or manipulate a maximum load of:

- **Continuously** 1.6 kg from minimum to middle reach (45 cm distance between actuator #2 and the load).
- **Temporary** 1.3 kg from middle to full reach (90 cm distance between the actuator #2 and the load).

The robot is designed to be able to hold objects in the environment of the user, but it is a manipulator that in some positions and loads near the maximum reach and maximum loads holds for a long period, it can heat. When this occurs, before overheating and being dangerous for either the user or the robot, red lights on the joystick will blink. This is a warning. Simply put down any object in the gripper, and bring back the robot to the HOME or RETRACTED positions and wait until the warning goes away before using the robot.

 When lifting weight near the maximum load and reach, if the red lights of the controller blinks, put down the object in the gripper, and bring back the robot to HOME or RETRACTED position and wait until the warning goes away before using it.



Note: During normal operation, the joints are subject to heating. The joints are normally covered with plastic rings which will protect the user from any danger that may be occurred by the heating of the metal parts.

The fingers of the robot are made flexible in order to protect the internal mechanism. When using the fingers to push on objects, the user must take special care not flex the fingers beyond their maximal opening as this could damage the internal mechanism.



Do not force the fingers beyond their maximal opening as this could damage some internal components.

Electromagnetic interference from radio wave sources

This section describes electromagnetic interference considerations for the robot.

Even if the product complies with all relevant standards, your robot may still be susceptible to electromagnetic interference (EMI), which is interfering electromagnetic energy (EM) emitted from sources such as radio stations, TV stations, amateur radio (Ham) transmitters, two way radios, and cellular phones. The interference (from radio wave sources) can cause the product to stop moving for a period of 10 seconds. In this case, the device will simply re-initialize and you will be able to continue to use it. In extremely rare case, it can also permanently damage the control system.

The intensity of the interfering EM energy can be measured in volts per meter (V/m). The product can resist EMI up to certain intensity. This is called “immunity level”. The higher the immunity level is, the greater is the protection. At this time, current technology is capable of achieving at least a 20 V/m immunity level, which would provide useful protection from the more common sources of radiated EMI.

There are a number of sources of relatively intense electromagnetic fields in the everyday environment. Some of these sources are obvious and easy to avoid. Others are not apparent and exposure is unavoidable. However, we believe that by following the warnings listed below, your risk to EMI will be minimized.

The sources of radiated EMI can be broadly classified into three types:

1. Gripper-held portable transceivers (e.g. transmitters-receivers with the antenna mounted directly on the transmitting unit, including citizens band (CB) radios, walkie-talkie, security, fire and police transceivers, cellular phones, and other personal communication devices). Some cellular phones and similar devices transmit signals while they are ON, even if not being actively used.

2. Medium-range mobile transceivers, such as those used in police cars, fire trucks, ambulances and taxis. These usually have the antenna mounted on the outside of the vehicle.
3. Long-range transmitters and transceivers, such as commercial broadcast transmitters (radio and TV broadcast antenna towers) and amateur (Ham) radios. Other types of gripper-held devices, such as cordless phones, laptop computers, AM/FM radios, TV sets, CD players, cassette players, and small appliances, such as electric shavers and hair dryers, so far as we know, are not likely to cause EMI problems to your device.

Because EM energy rapidly becomes more intense as one move closer to the transmitting antenna (source), the EM fields from gripper-held radio wave sources (transceivers) are of special concern. It is possible to unintentionally bring high levels of EM energy very close to the control system while using these sorts of devices. Therefore, the warnings listed below are recommended to reduce the effects of possible interference with the control system.

 Do not operate gripper-held transceivers (transmitter-receivers), such as citizens band (CB) radios, or turn ON personal communication devices, such as cellular phones, while the device is turned ON.

 Be aware of nearby transmitters, such as radio or TV stations, and try to avoid coming close to them.

 Be aware that adding accessories or components, close to the device may make it more susceptible to EMI.

 Report all incidents of unintended shut down to your local distributor, and note whether there is a source of EMI nearby.

Operating and controlling the robot

Jaco is meant to be connected and controlled through the joystick on a power wheelchair joystick.

The Jaco is meant to be connected and controlled through the power wheelchair's joystick. Operate the Jaco through the power wheelchair menu. The Jaco functions are featured on the OLED display; the section "OLED display accessory".

To control the Jaco, options other than the power wheelchair joystick are available. The Kinova joystick controller is one option; its functions are detailed in the section "Kinova joystick controller". For more options to control the Jaco through other joysticks, please refer to your Kinova-certified contact.

Another option that gives more flexibility in operating the Jaco is the Kinova Lift arm. The Lift arm accessory is explained in the section "Lift arm accessory".

Related topics

[Kinova joystick controller](#) on page 19

[Operating the robot via joystick](#) on page 22

[OLED: General information](#) on page 29

[Lift arm: General information](#) on page 47

Kinova joystick controller

The Kinova standard controller is a three-axis (left/right, forward/back, and twist) joystick mounted on a support. The controller includes five independent push buttons and four external auxiliary inputs (on the back side).

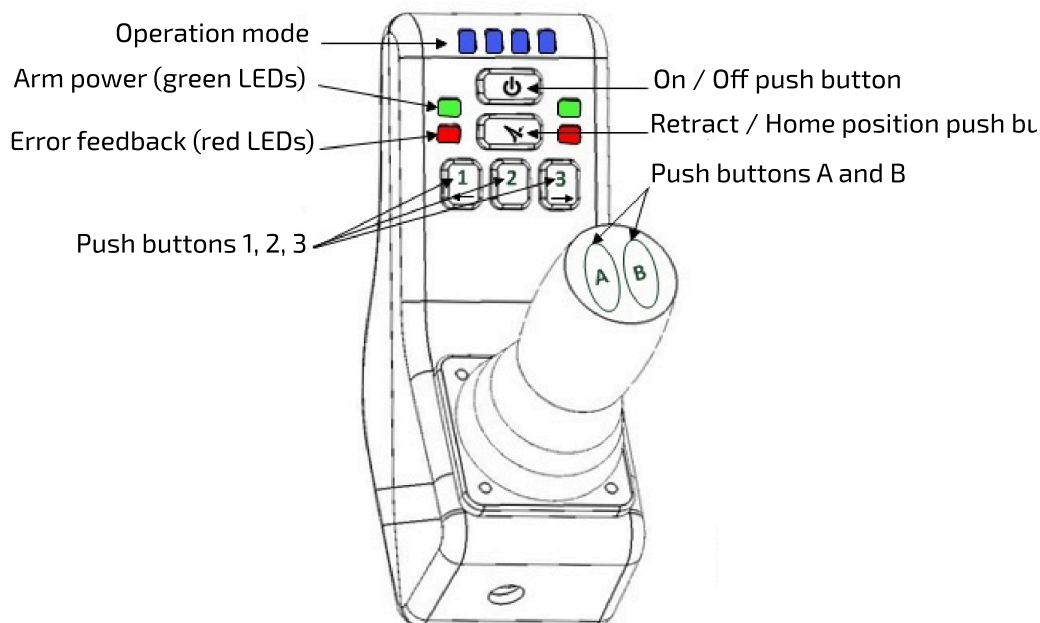



Joystick movements and modes

The Kinova joystick allows you to control the robot in a **2-axis** or **3-axis** mode. 2-axis mode will disable the joystick twist rotation.

The following table shows the button default factory settings for using the joystick in a 2-axis and 3-axis modes.

Table 3: Default joystick button settings

Buttons	One click	Hold 2 sec (Hold until position is reached)
	Deactivate / Activate Joystick	Change joystick operating mode (2-axis Vs 3-axis)
	---	Home / Retracted function
3-Axis		
1	Deactivate / Activate Drinking mode	---
2	---	Set Position
3	---	Go to pre-set position
A	Reach Finger mode	Decrease speed
B	Reach Translation & Wrist mode	Increase speed
Ext1	Reach Finger mode	Decrease speed
Ext2	Reach Translation and Wrist mode	Increase speed
Ext3	--	Home / Retracted function
Ext4	Deactivate / Activate Drinking mode	--
2-Axis		
1	Deactivate / Activate Drinking mode	---
2	Reach Wrist orientation & Finger mode	Decrease speed
3	Reach Translation-X/Y & Translation-Z / Wrist rotation mode	Increase speed
A	---	---
B	---	---
Ext1	Reach Wrist orientation & Finger mode	Decrease speed
Ext2	Reach Translation-X/Y & Translation-Z / Wrist rotation mode	Increase speed
Ext3	--	Home / Retracted function
Ext4	Deactivate / Activate Drinking mode	--

Operating principles and Cartesian mode

This section describes at a high level the control of the robot using the joystick in Cartesian mode.

Operating principles

The operating principles are very simple and intuitive. The robot may be operated through several controllers. The following sections present the general control principles through Kinova's joystick.

Basic movements

The normal control of the robot with the joystick is said to be Cartesian. The user commands the tool translations (position variations) with respect to the base and the rotations (orientation variations) around the tool reference frame. The different joints are piloted automatically following the given command.

In **Translation mode**, the user controls the position of the gripper / tool in space. The gripper will always keep the same orientation with respect to the robot base.

- Translation X refers to left/right movements of the gripper
- Translation Y refers to front/back movements of the gripper
- Translation Z refers to up/down movements of the gripper

In **Wrist mode**, the user controls the position of the gripper around its center point (reference point) which will not move (or move slightly) when operating in this mode. Lateral orientation refers to a thumb/index circular movement of the wrist around the reference point. Vertical orientation refers to a top/bottom circular movement of the wrist around the reference point. Wrist rotation refers to a circular movement of the gripper around itself.

Drinking mode is to be used with the wrist rotation only. While operating the robot in **drinking mode**, the reference point (normally set in the middle of the gripper), is offset in height and length to produce a rotation around another point in the space of the robot.



Note: The offset is meant to shift the rotation center for wrist rotation from the center of the gripper to a point corresponding to the rim of a typical sized drinking glass held by the gripper. This way, the wrist will rotate, but around a point on the rim of a virtual glass, aided by movement of the elbow of the robot arm. This is similar to the way we coordinate an adjusted rotation of our wrist with movement of our forearm and elbow while drinking with a glass so that the glass tips its rim toward the mouth to pour.

In **Finger mode**, the user controls the opening and closing of the fingers.



Note: The robot will sometimes respond differently to a given command than described in this section. This may be due to the singularity and collision avoidance algorithms

embedded in the kinematics. It is a normal protective behaviour of the robot and is position dependent.

Operating the robot via joystick

This section describes operation of the robot using the joystick.

This section explains how to operate the robot with factory configuration. Contact your reseller for operation instructions in the case of an adapted configuration.



Before operating the robot, please make sure it is properly installed.



Do not manipulate cutting, very sharp or any dangerous tools or objects with the robot.



This equipment is not designed to act as a lift.



This equipment is not designed to be used in presence of flammable mixture. (Not AP or APG rated).



Do not install the robot near any heat sources, such as radiators. Do not use it to directly manipulate hot objects.

Joystick control quick start

This section describes how to get started using the Kinova joystick to control the robot in the default configuration.

Before you begin

The joystick needs to be connected to the robot.

About this task







This procedure provides a quick hands-on walkthrough of controlling the robot with the joystick.

Procedure

1. Turn ON the device by pushing the ON/OFF switch located on the robot base.
2. Wait until the green lights on the controller stop flashing.
3. Put the robot in its Home position by holding down the HOME/RETRACTED button until the robot stops moving. The robot will slowly reach the Home position.



Note: When starting the robot, you are in 3-axis operation mode, **Translation control mode**, meaning that any movement of the joystick will move the center of the gripper parallel to the floor.

4. You may move the 3 axes of the joystick to try out Translation control mode.
 -  **Note:** To change the operating mode of the Joystick, hold the ON/OFF button for 2 seconds. At this point, you are in 2-axis mode and the stick rotation is deactivated.
5. One press of Button B will bring you in **Wrist control mode** meaning that any movement of the joystick will result in a rotation of the gripper around its center.
 -  **Note:** Another press of Button B will bring you back in Translation control mode.
6. One press of Button 1 will activate **Drinking mode** which may be used only in Wrist mode. When rotating the joystick lever, you will see that the robot's wrist rotation now compensates for the height and radius of a virtual glass. This movement is ideal when trying to use the robot to drink directly from a glass.
 -  **Note:** Another press of Button 1 will disable Drinking mode.
7. One press of Button A will bring you in **Finger control mode**. The fingers will move per a left/right inclination of the joystick.
 -  **Note:** At any time, you may use the Home / Retracted button until the robot stops moving to bring it back to its Home position.
 -  **Note:** If you hold the Home / Retracted button again, the robot will start to move toward the Retracted position.
8. Hold the On/Off Button for 2 seconds to change the operating mode. This will disable the stick rotation. You are now in a 2-Axis Translation control mode. Stick rotation won't have any effect and you will only be able to control the horizontal translation of the robot (X- and Y- axis).
9. One press of Button 3 will bring you to control the vertical translation of the gripper (Translation-Z) and Wrist rotation.
 -  **Note:** Another hit on Button 3 will bring you back in Translation-X and Translation-Y control mode.
10. One press of Button 1 will activate Drinking mode again
11. One press of Button 2 will bring you to control the wrist orientation (Lateral orientation and Vertical orientation).
12. Another press of Button 2 will bring you to Finger control mode. The fingers will move according to a left/right inclination of the joystick.
 -  **Note:** Another press of Button 2 will bring you back in Lateral orientation and Vertical orientation control mode.

Default joystick motion settings - Cartesian three-axis mode

This section describes default motion settings in Cartesian three-axis mode.

Table 4: Three-axis mode joystick controls

Joystick movement	Robot movement	Availability
Translation mode		
Incline FRONT	Gripper moves forward	4 / 6 / 6S / 7S DoF
Incline BACK	Gripper moves backward	4 / 6 / 6S / 7S DoF
Incline LEFT	Gripper moves left	4 / 6 / 6S / 7S DoF
Incline RIGHT	Gripper moves right	4 / 6 / 6S / 7S DoF
Rotate stick CLOCKWISE	Gripper moves up	4 / 6 / 6S / 7S DoF
Rotate stick COUNTERCLOCKWISE	Gripper moves down	4 / 6 / 6S / 7S DoF
Wrist mode		
Incline FRONT	Vertical orientation – top side	6 / 6S / 7S DoF
Incline BACK	Vertical orientation – bottom side	6 / 6S / 7S DoF
Incline LEFT	Lateral orientation – thumb side	6 / 6S / 7S DoF
Incline RIGHT	Lateral orientation – index side	6 / 6S / 7S DoF
Rotate stick CLOCKWISE	Wrist rotation clockwise	4 / 6 / 6S / 7S DoF
Rotate stick COUNTERCLOCKWISE	Wrist rotation counterclockwise	4 / 6 / 6S / 7S DoF
Finger mode		
Incline LEFT	Close Fingers (3-finger mode)	4 / 6 / 6S / 7S DoF
Incline RIGHT	Open Fingers (3-finger mode)	4 / 6 / 6S / 7S DoF

Default joystick motion settings - Cartesian two-axis mode

This section describes default motion settings in Cartesian two-axis mode.

Table 5: Two-axis mode joystick controls

Joystick movement	Robot movement	Availability
Translation-X and Translation-Y		
Incline FRONT	Gripper moves forward	4 / 6 / 6S / 7S DoF
Incline BACK	Gripper moves backward	4 / 6 / 6S / 7S DoF
Incline LEFT	Gripper moves left	4 / 6 / 6S / 7S DoF
Incline RIGHT	Gripper moves right	4 / 6 / 6S / 7S DoF
Translation-Z and Wrist Rotation		
Incline FRONT	Gripper moves up	4 / 6 / 6S / 7S DoF
Incline BACK	Gripper moves down	4 / 6 / 6S / 7S DoF
Incline LEFT	Wrist rotation clockwise	4 / 6 / 6S / 7S DoF
Incline RIGHT	Wrist rotation counter-clockwise	4 / 6 / 6S / 7S DoF
Wrist Orientation		
Incline FRONT	Vertical orientation – Top side	6 / 6S / 7S DoF
Incline BACK	Vertical orientation – Bottom side	6 / 6S / 7S DoF
Incline LEFT	Lateral orientation – Thumb side	6 / 6S / 7S DoF
Incline RIGHT	Lateral orientation – Index side	6 / 6S / 7S DoF
Finger Mode		
Incline LEFT	Close Fingers (3 finger mode)	4 / 6 / 6S / 7S DoF
Incline RIGHT	Open Fingers (3 finger mode)	4 / 6 / 6S / 7S DoF

Joystick LED feedback

The Kinova joystick offers visual feedback:













































- Blue LEDs: control mode
- Green LEDs: robot power
- Red LEDs: error condition(s)

Joystick blue LED feedback

This section describes the blue LED feedback on the Kinova controller.

The blue LEDs on the controller give feedback on the current control mode. The interpretation of the blue mode LED indicators is described in the following table.

Table 6: Control mode feedback

Blue LED indication		Control mode
3-Axis	   	Translation (X-Y-Z)
	   	Wrist
	   	Fingers
	   	Drinking mode (to be used with wrist rotation mode)
	   	Disabled controller
2-Axis	   	Translation (X-Y)
	   	Translation (Z) / Wrist Rotation
	   	Wrist Orientation
	   	Fingers
	   	Drinking mode (to be used with wrist rotation mode)
	   	Disabled controller

When no blue lights are visible, the controller is disabled. To enable the controller, you must either proceed with the following options:

- The On / Off button must be depressed.
- The robot must be set in its HOME position by holding the HOME/RETRACTED function until the robot stops moving.

Joystick green LED feedback

This section describes the green LED feedback on the Kinova joystick.

The green lights offer visual feedback on the power status of the robot.

Table 7: Power status feedback

Green LED indication	Power status
Flashing	The internal communication is still synchronizing after the robot has been turned on. It is not yet ready to use.

Green LED indication	Power status
Solid	The robot is powered and ready to use.

Joystick red LED feedback

This section describes the red LED feedback on the Kinova controller.

The red lights offer visual feedback on possible errors that may occur while operating the robot:

Table 8: Error status feedback

Red LED indication	Cause of the error status	Action to resolve the situation
Flashing	The weight being lifted is too heavy, or too much force is applied on the robot.	Safely put down the object, or release force applied on the robot, and wait until red lights turn off.
	The temperature of a section of the robot is too high.	The usage of the robot is excessive and doesn't respect the normal use definition. Safely put down any object that is in the gripper, bring back the robot to its RETRACTED position, and wait until the red lights turn off.
	The input voltage to the robot (or batteries) is too low or too high.	Safely put down any object that is in the gripper, bring back the robot to its RETRACTED position. Ensure the power supply is appropriate, connections are secure and batteries are charged properly before using the robot again.
Solid	The robot is in a fault mode	Turn off the robot and turn it back on. If the problem remains, contact your distributor or Kinova.

Packing materials

The product packing material can be disposed of as recyclable material.

Metal parts

Metal parts can be disposed of as recyclable scrap metal.

Electrical components, circuit boards, and carbon fiber

Please contact your local distributor for information regarding disposal of such parts. You can also address questions directly to Kinova through our website; see Contacting Support.

Carrying case

Reuse the carrying case to store the robot arm when it is not installed or in use. Also, transport the robot arm in the carrying case.

OLED display accessory

OLED: General information

The Kinova OLED display is an optional accessory that was designed to make the control of the robot more intuitive by providing users with a visual reference of the current modes and status of the robot.

The display was designed to be used with Kinova's Universal Interface. Using the display without the Universal Interface device may result in undesired behavior. The device connects to the universal interface using Kinova's standard circular connectors. The device communicates with the robot by using Kinova's proprietary CAN communication protocol.

Dimensions

The OLED display is the size of a smart phone.

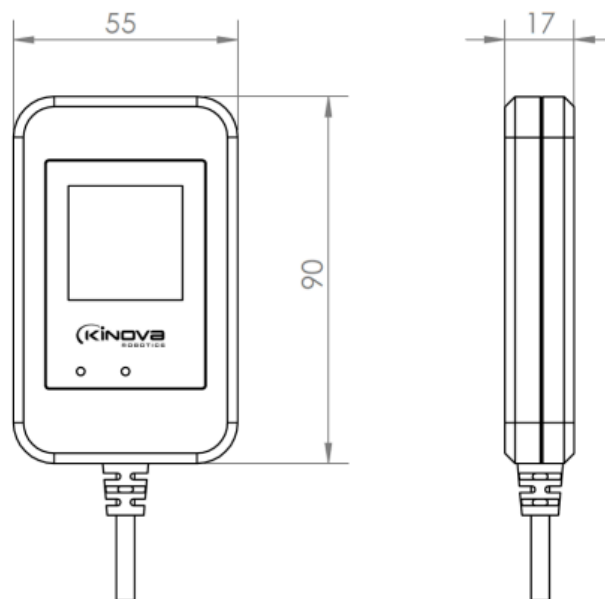

Figure 3: Display module dimensions



All dimensions are in mm.

Identification of parts

The OLED display has a simple interface.

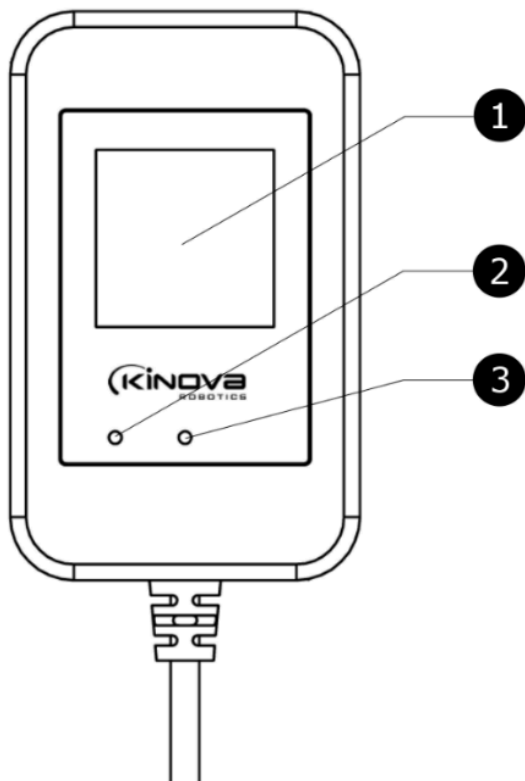





Figure 4: Identification of parts of the display module

Reference Number	Description
1	<p>LCD SCREEN</p> <p>Color liquid crystal display screen used to display information on the robotic arm modes and status.</p>
2	<p>LED INDICATOR</p> <p>The blue LED indicator is used to give feedback on the display power and connection status at start up.</p> <ul style="list-style-type: none"> • Power Up sequence: The indicator will blink • Normal working mode: The indicator should be on • Stand-by mode: The indicator is off

	<p>AMBIENT LIGHT SENSOR</p> <p>The ambient light sensor is used to sense environmental lighting conditions and adjusts the screen’s brightness accordingly.</p>
---	--

Specifications

The OLED display can function within specific conditions.

Environment		
General	Ambient temperature	-20°C to 70°C
	Light rainfall	a limited period of time (IPX2)
	Normal atmospheric pressure conditions	
Storage	Ambient temperature	0°C to 50°C
	Maximum relative humidity	55%
Electrical		
Power Ratings	Voltage	24 VDC
	Current consumption	0.09A max
		0.5A fused
Water resistance		
General	Light rainfall	limited period of time (IPX2)
		minimal exposure to rain
Warnings	 Do not submerge device under water	
	 Do not expose device to water with moving force	
	 If the device is dropped, hit, or endures any damage, the water resistance may be affected	

Installation guidelines

Following the general guidelines ensures successful installation of the control system components.

Mounting

The display comes equipped with industrial Velcro™ installed on the back of the device. Peel off the protective plastic and stick the Velcro™ to the desired surface. For optimal mounting, use the Kinova display holder (Part number: AM 1241 0001).

Position

The display should be installed in a proper position so that the user can see the screen and feedback lights clearly from his normal position in the wheelchair.



Make sure that the device is not blocking the user's view of critical areas.



Make sure that the device or mounting system does not interfere with the wheelchair controls.

Cables

Cables should be mounted in a way to prevent damage to the cables or safety hazard for the user.

❗ Make sure they do not interfere with motion of the wheelchair or any of its components and accessories.

❗ Do not overtighten the tie wraps as this could result in cable damage.

❗ Make sure there are no free hanging cables or big cable loops hanging outside the wheelchair's wheelbase to prevent any interference with the surrounding environments.



Route the cable in a way that it will not be subjected to pinch points. Be very careful around lift mechanism, hinges and pivot points. A cable that is not installed properly can result in a cable damage and electrical hazard.



Do not try to modify, cut or alter cable in any way.

Connecting the display

The display uses a circular 8-pin connector type that must be connected to the correct port; the port used for connecting depends on the product.

Before you begin

Follow all installation safety precautions.

- **!** If you are having some difficulties when trying to connect the circular connector to the Universal Interface, do not try to apply more force. You may be using the wrong port. The Universal Interface uses multiple types of similar circular connectors, each with different pin configurations.
- **!** Do not over tighten the connector. Screw the connector using two fingers and stop when you encounter some resistance.
- **!** Always power-off the system before plugging and unplugging any connectors.

About this task

The two types of displays that can be connected are the Universal Interface V1 and the Universal Interface V2.

Procedure

- Connect the display according to which display is available.

Universal interface V1 (PC 0000 0002)

Connect the display to the Auxiliary port #1.

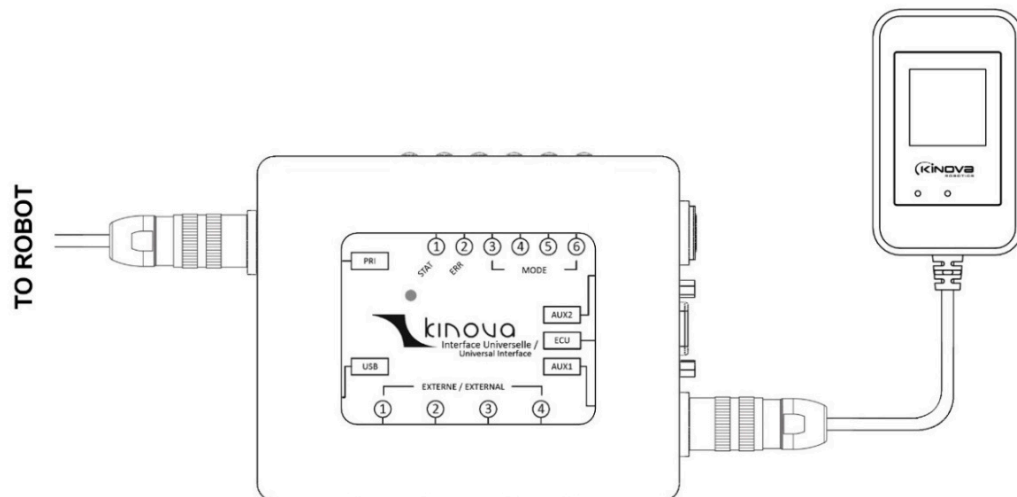
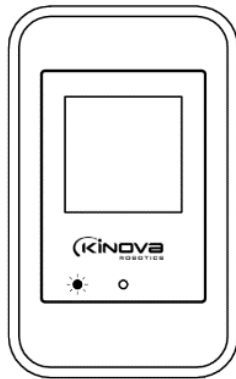

Figure 5: Universal interface V1 connection

Universal interface V2 (PC 0000 0003)

Connect the display to the PASS port.

1. Blank screen



- No display for about ten (10) seconds
- Blue indicator light denotes the display is receiving power

2. Kinova logo

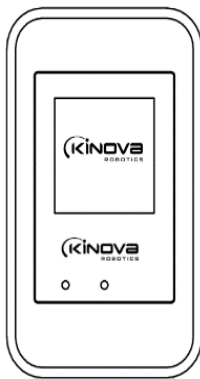

- Kinova logo is displayed for about 5 seconds
- Blue indicator light is Off

3. Settings screen

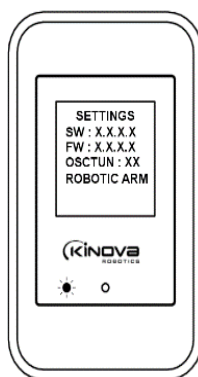

- Settings information is displayed for up to two (2) seconds
- Blue indicator light blinks. For troubleshooting purposes, the support technician may request to have the setting screen information



Note: For troubleshooting purposes, the support technician may request the setting screen information. If you did not have time to note everything, you can see it again by rebooting the robot arm.

Screen sections

Each of the four (4) sections of the display has a specific purpose.

The location of each section of the display is highlighted in black.

Main section

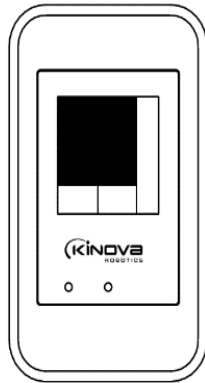

The main section displays two types of movements.

- Possible movements: movements that are possible to take in the current mode
- Active movements: movements that are currently in progress

Status section

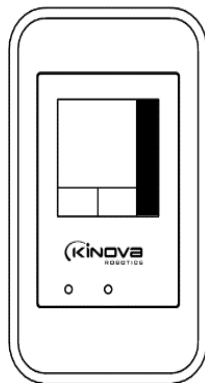

The status section displays different arm status information.

Mode section

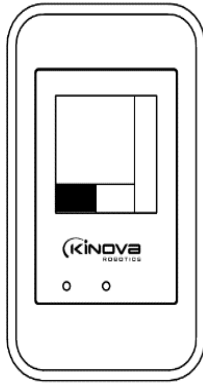

The mode section displays the current mode and index.

Function section

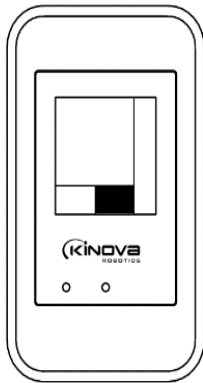

The function section displays two (2) types of information related to functionality.

- Function details
- Error and warning signals

Status section

The status section regroups all icons that are related to the status of the robot's movement.

Different icons are used to report the status of the movement.

- retract status
- drinking mode
- robot speed

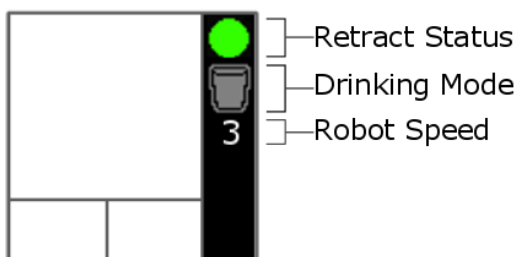





Figure 7: Status section, and its details, of the display

Retract status icon

The retract icon is represented by a green or orange circle. It is used to communicate the state of the robot.



Table 9: Retract status icon states

Icon	State	Information
 Steady Green	Ready	The arm is ready to use and can be controlled by the user.
 Steady Orange	Retracted	The arm is in its retracted, or stored, position.
 Blinking Orange	In Progress	The arm is between its home, or ready, position and its retracted, or stored, position.  The user should press and hold the retract button to move the robot to the retracted or ready position.

Drinking mode icon

The drinking mode icon is represented by a glass.

Table 10: Drinking mode icon states

Icon	Information
 Greyed-out glass	The drinking mode is available in the current mode, but is not currently active.
 Colored glass	The drinking mode is currently active.

Icon	Information
No glass	The drinking mode is unavailable and inactive.

Robot speed icon

The speed icon is represented by a number. The larger the number, the faster the arm moves.

Table 11: Drinking mode icon states

Number	Information
1	Lowest speed
2	Low speed
3	High speed
4	Highest speed

Mode section

The current mode is used to communicate information about the currently active controller mapping.

The mode section displays two types of information.

- current mode list
- current mode list index

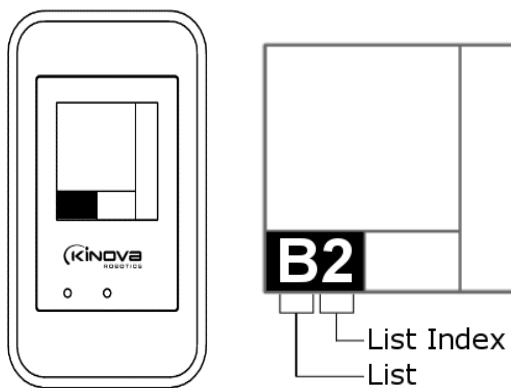

Figure 8: Mode section, and its details, of the display

The two current mode lists are named A and B.

The current mode list index is a list of the different controller mappings that are available. Each list can store up to six (6) different controller mappings, each represented by a number from 1 to 6.

Function section

The function section is primarily used to display available advanced arm functionalities, such as pre-recorded positions, advanced pre-recorded positions, and automatic orientation.

Additionally, this section is also used to display errors and warnings.

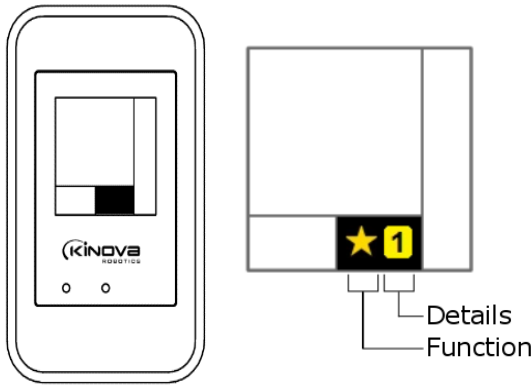

Figure 9: Function section, and its details, of the display



Functions and their details are represented by icons.



There are three types of functions.

- available
- active
- warnings

When a special function, or multiple special functions, are available in the current mode, the available function is displayed on the left side of the Function section.

Table 12: Available function icons

Icon	Information
 Star with red circle	The current mode has both RECORD and Goto functions available in the current mode
 Star with letter S	Only standard Goto pre-defined positions are available in the current mode
 Star with letter A	Only advanced Goto pre-defined positions are available in the current mode

Icon	Information
 Star with letter O	Only automatic orientations are available in the current mode
 Star with no letter	The current mode has more than one different types of functions available in the current mode, but no RECORD

When a specific function is activated, the type and index are displayed. After five (5) seconds, the index goes blank and the function type returns to the original Available Function icon for the current mode.

Table 13: Active function icons

Function type icons	Index icon	Information
 Standard Goto		Index of the running advanced Goto command
 Advanced Goto		Index of the running advanced Goto command
		The +/- icon indicates that an “add current position” command or a “clear advanced Goto” command has been sent.
 Automatic Orientation		Hand facing up
		Hand facing down
		Hand facing left
		Hand facing right
		Hand facing forward
		Hand facing backward



Whenever an error occurs, an orange triangle overrides the Goto indicator until the error is cleared. Errors are grouped as minor or major.

Table 14: Warning icons

Icon	Information
 Orange Triangle	Minor errors: <ul style="list-style-type: none"> • Display beeps twice • Main section not affected
	Major errors: <ul style="list-style-type: none"> • Display beeps four times • Main section displays red robot arm

Function icon and index flow

The function icon changes according to the current condition created by the user. Each step describes the icon that is displayed the condition and the condition under which it is displayed. Take this as a example of how the icons change in the Function section.

-  The empty star is displayed in the Function section.
 - No joystick command is sent
 - One standard Goto and one automatic orientation is present in the current mode
-  **2** The icon changes to a star with the letter "S" inside it to indicate a Standard Goto command is invoked.

User presses the button corresponding to the function Standard Goto 2.
-  **2** The icon returns to the empty star. The number 2 is displayed; the function Standard Goto 2 is still executing.
 - User is pressing the **Goto 2** button
 - More than five (5) seconds has elapsed

Main section

The main screen is used mainly to communicate information about the available and active movements of the robotic arm. It also communicates whether the left or right hand mode is in use.

Available movements and active movements

Available Movements in the currently active mode are indicated by a green arrow representing the direction of the movement. *Active Movements* are represented by a yellow highlight around the currently active movement arrow.



Figure 10: Available movement



Figure 11: Active movement

Arm laterality

Arm laterality means whether the arm is using a right hand or a left hand mode. The laterality determines whether the drawing of the robot arm is mirrored. Some direction arrows may also be mirrored.



Figure 12: Example of right hand laterality



Figure 13: Example of left hand laterality

Movements display

Possible movements are dictated by the configuration of the control mapping of the robot.

The robot has basic movements.

- translation
- orientation
- finger

Translation movements

Translation movements are also known as Cartesian movements.



Figure 14: Left and right



Figure 15: Up and down



Figure 16: Forward and backward



Figure 17: Example of translation movement

Orientation Movements

Orientation movements are also known as rotation movements.



Figure 18: Rotate right and left **Figure 19: Rotate up and down** **Figure 20: Rotate wrist**



Figure 21: Example of orientation movement

Finger movements

The finger movements are a little bit different than other movements. When available, the fingers change color to orange. When the movement is activated, the arrows representing the movements are displayed. The number of arrows represents the number of moving fingers.



Figure 22: Example of available finger movement



Figure 23: Example of active finger movement

Sleep mode

To save energy and avoid unnecessary distractions, the display enters Sleep mode after three (3) minutes of inactivity.

The display wakes up if any button is pressed or any joystick movement is detected.

Major errors

When major errors with the device occur, the display enters Major Error mode.

The display beeps four (4) times to draw the user's attention and displays the Major Error icon.

The major error goes back to the Standard Mode when the error is cleared.

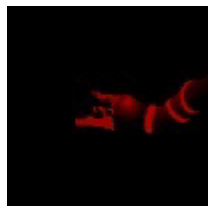

Figure 24: Display of major error

Joystick and communication error

When there is an error with the controller or the display cannot communicate with the robot for any other reason, a joystick with an X is displayed in the main section of the OLED display.



Figure 25: Joystick and communication error icon

Communication Lost error

When the communication between the display and the robot is interrupted, the reconnect icon is displayed in the main section.



Figure 26: Reconnect icon



Do not try to disconnect and reconnect the display module or the universal interface while the robot is

powered on. Always power off the system before plugging and unplugging any connectors.

Lift arm accessory

Lift arm: General information

This section describes the purpose of the lift arm.

The lift arm is an accessory that can be used to mount Jaco onto a powered wheelchair. The lift arm mechanism increases the range and flexibility of the robotic arm (robotic arm sold separately).

A swing-away mechanism lets you move the lift arm and robotic arm out of the way temporarily to facilitate getting into and out of the wheelchair.



The robotic arm and lift arm will still function when the lift arm is swung out. However, they should not be used when the swing-away mechanism is engaged.

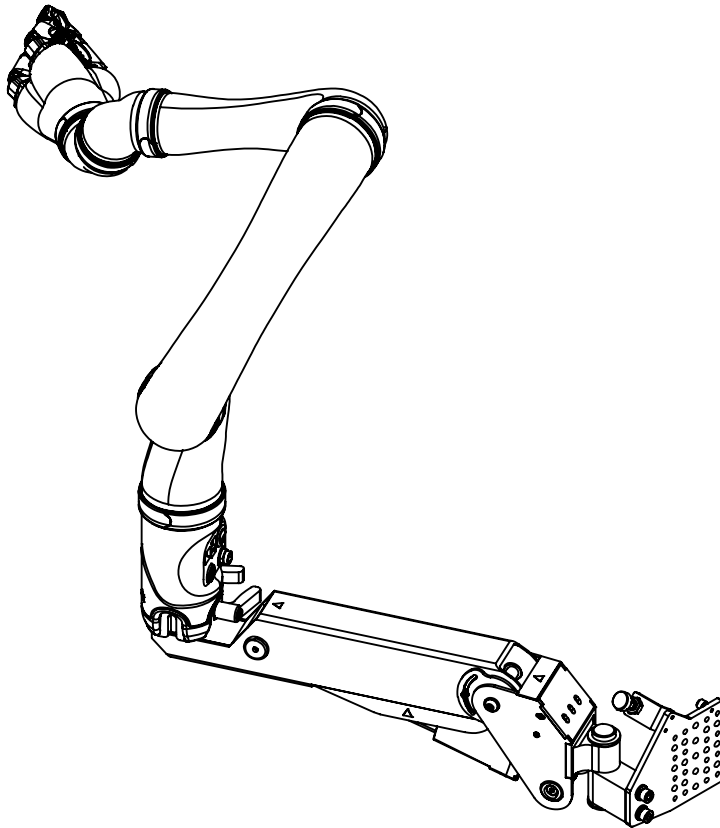

A lift mechanism (tilt forward) makes it easier to reach objects that are low (something on the floor or under a table).

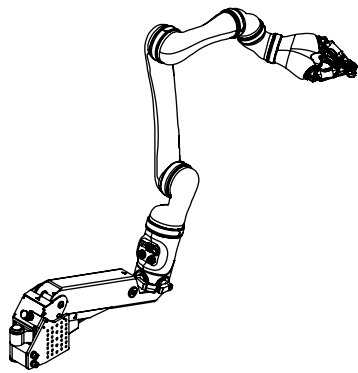

Tilted 2° down

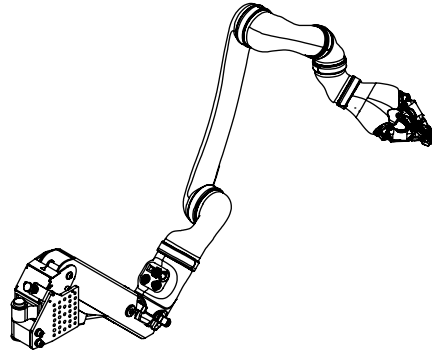

Tilted 4°5 down

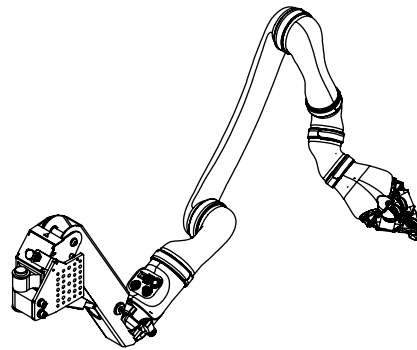

Tilted 6° down

The lift arm is available in both left and right handed configurations, depending on which side of the powered wheelchair the device will be installed on.

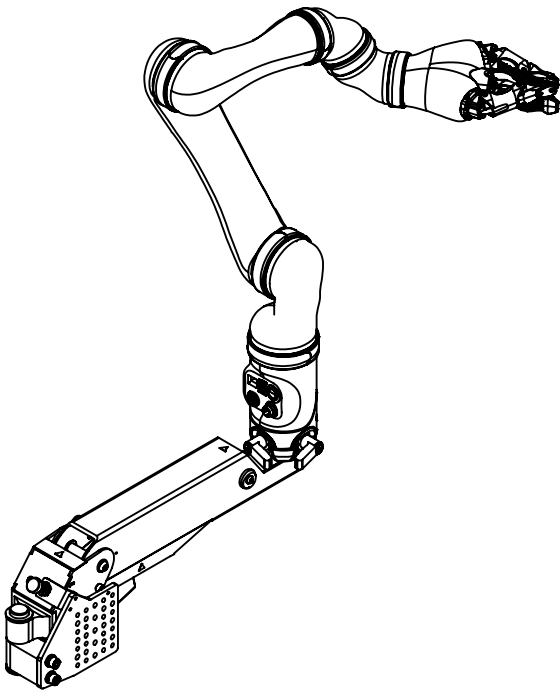

LHS lift model

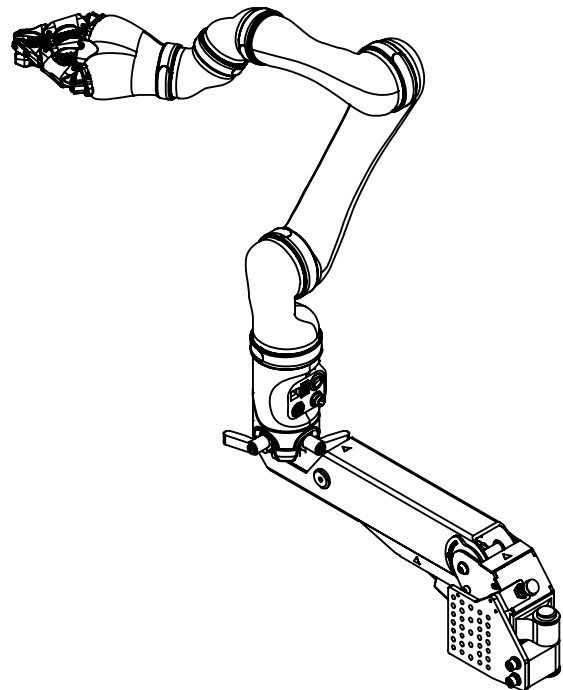

RHS lift model

Lift arm specifications

This section describes dimensions and specifications of the lift arm.

- Weight: 5.6 kg (12.3 lbs)
- Dimensions (including mounting clamps): 500mm x 116mm x 164mm
- Control box dimensions: 115mm x 95mm x 55mm
- Swing-away mechanism maximum angle: no limit other than running into the wheels or side of the wheelchair, depending on the setup and wheelchair
- Maximum tilt forward angle: 64°
- Maximum tilt backward angle: 3°
- Maximum Duty cycle: 10% (operation for 2 minutes maximum in every 20 minute period)
- Electrical rating: 24V, max 2.7A

Weight and dimensions are for the lift arm alone and do not include Jaco.

Refer to [Table 1: Specifications](#) on page 12 for maximum allowable payload.

Lift arm components

This section describes the main components of the lift arm.

The lift arm system consists of the lift arm itself, a control box, and push-button controls.

The lift arm is made up of:

- Wheelchair mounting bracket - for mounting the lift arm on the wheelchair
- Robotic arm mounting post - a mounting point for the robotic arm on the lift arm
- Electromechanical lift actuator - a motor to lower / lift the lift arm and robotic arm
- Lift actuator limit switch - sets a limit to how far forward the lift arm can tilt
- Body of lift arm - chassis / frame housing the lift actuator and supporting the weight of the mounted robotic arm
- Hinged swing-away mechanism with hinge and latch - allows the lift arm to swing away from the wheelchair to facilitate entry and exit from the wheelchair
- Bumper screw - prevents wobble in the swing-away latch (not shown)

Swing-away mechanism latch

Bumper screw

Body of lift arm

Robotic arm
mounting post

Wheelchair mounting bracket

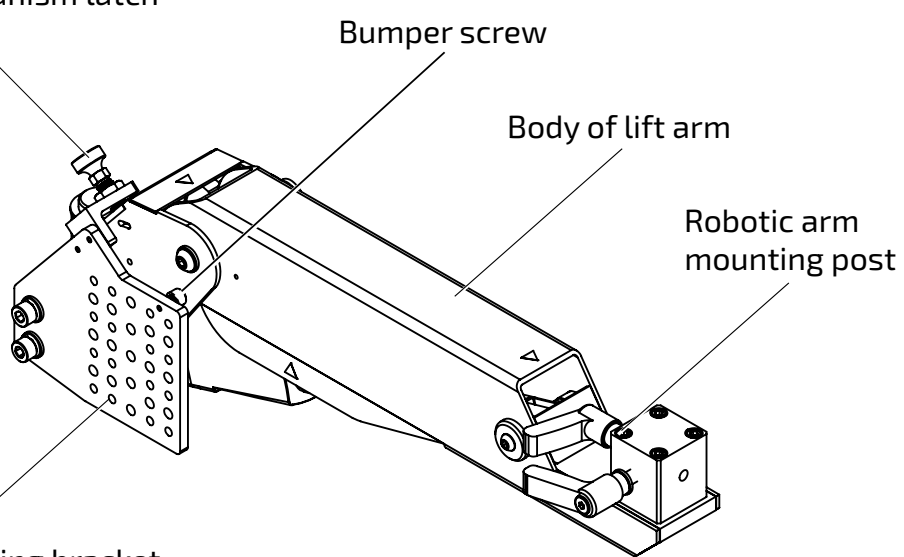

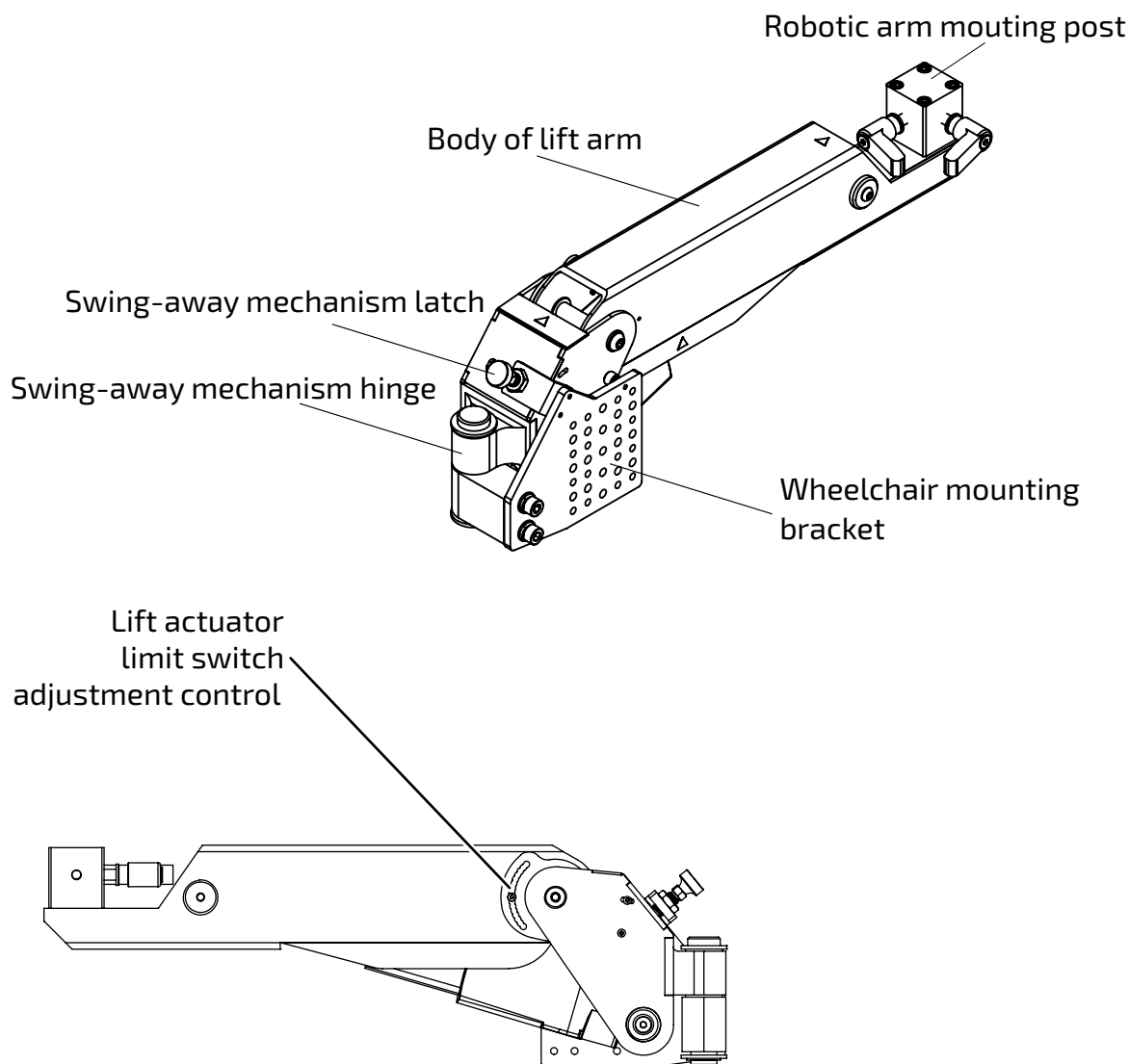

Lift arm limit switch

This section describes the lift arm limit switch.

The lift arm includes a limit switch. This serves to limit the extent to which the lift arm tilts forward.

This angle limit is adjustable during installation.

⚠ The limit switch should only be adjusted by a Kinova-approved professional.

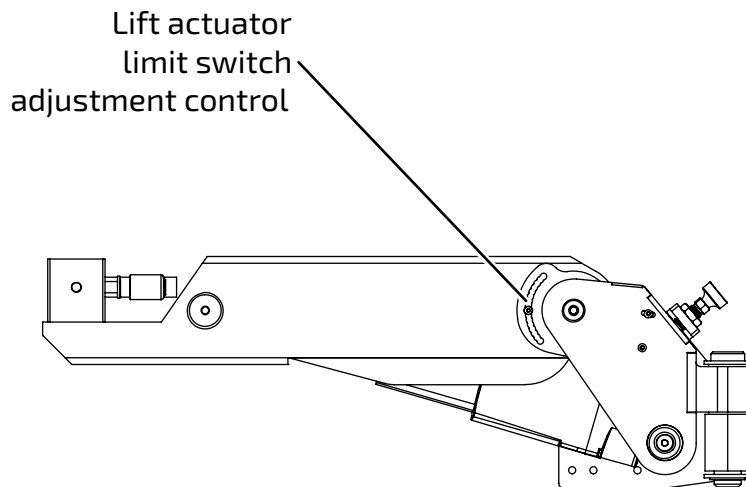

When the tilt forward of the lift arm reaches the angle limit, the lift arm will no longer respond to inputs from the user tilt forward push-button control.

Controlling tilt back / forward control

This section describes the control of the lift arm to tilt the arm forward or backward.

Control buttons let the user control the tilt-forward and tilt-backward functionalities.

There are two separate buttons. One button is used to make the lift arm tilt forward, and the other button causes the lift arm to tilt back.

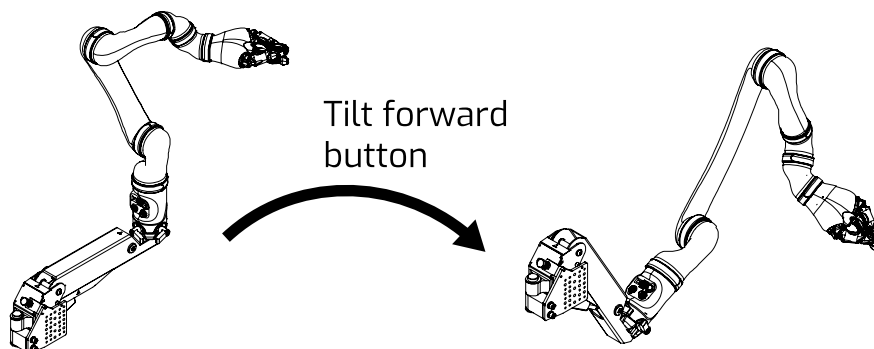

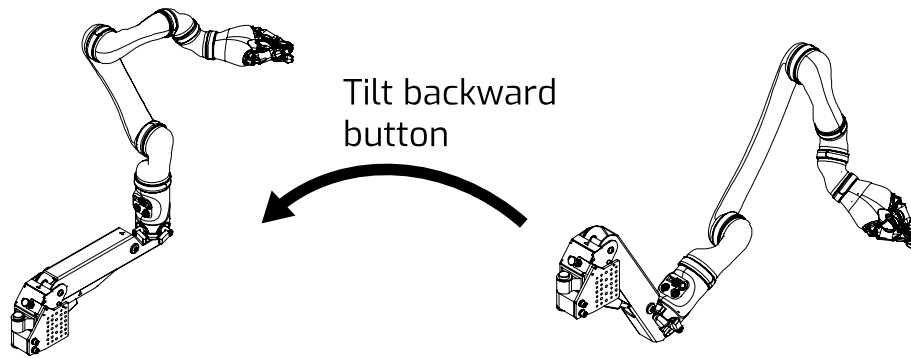

Hold down the appropriate button until the lift arm is inclined to the desired level, and then release. If you tilted the lift arm farther than you wanted to, simply use the other control to reverse direction and adjust accordingly.

Using the swing-away mechanism

This section describes how to use the swing-away mechanism on the lift arm.

The swing-away mechanism consists of:

- A hinge around which the rotation takes place
- A latch to keep the body of the lift fixed to the side of the wheelchair when the swing out mechanism is not in use

The swinging arm pivots around the hinge to swing out the body of the lift from the side of the wheelchair. When the swing-away mechanism is not in use, the mechanism is latched to the frame of the lift arm. The swing-away mechanism is meant to make it easier for the user to get out of the wheelchair on the side of the lift arm.

When it is time to use the swing-away mechanism, lift the latch to release it.

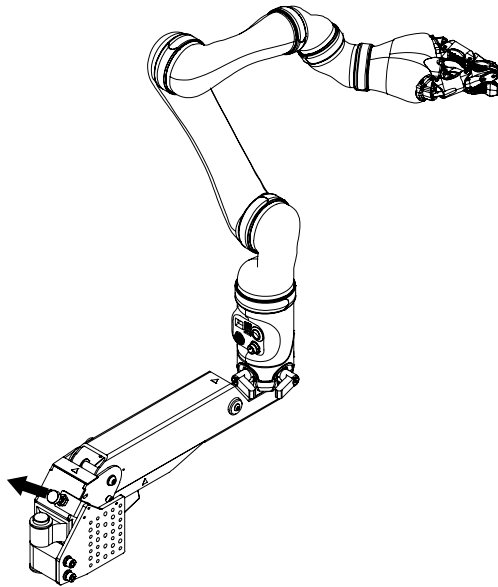

The lift arm is swung out and back manually.

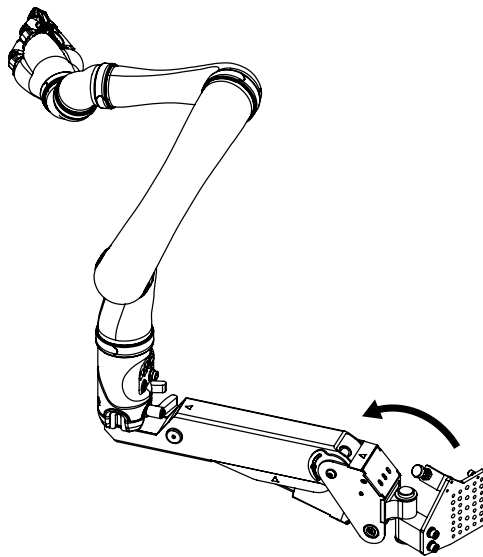

There is no powered control for this mechanism. End users may require assistance for this.



Note: At some angle, depending on the wheelchair and the setup, the lift arm will make contact with the side of the wheelchair or one of the wheels of the wheelchair. Don't try to force the lift arm to swing out farther than this natural limit.



Note: The lift mechanism and the robotic arm can still be activated when the arm is swung out. However, for safety reasons, it is recommended not to do so and is not considered to be normal use.

Cleaning, maintenance, and disposal

This section describes maintenance and disposal considerations.



Note: Do not reuse the product unless it has been re-installed by a certified technician.

Cleaning instructions

Only the external surfaces of the product may be cleaned. This is done using a damp cloth and a mild detergent. The following describes the steps for cleaning the product:

- Prepare a water/soap solution using about 2 ml of dish soap for 100 ml of water
- Immerse a clean cotton cloth in the solution
- Remove the cloth and wring out thoroughly
- Gently rub the external surface to be cleaned



Do not wash more than three times per day.



Do not immerse any part of the product under water or snow.



The product is not intended to be sterile. No sterilization process should be undertaken with the product.



Do not rub the external surfaces with abrasive materials.

Cleaning instructions of the Lift arm

- To clean the lift arm, it is best to use a lightly moistened cloth (without dripping) to clean the outer case.
- Internal components such as the motor or the mechanism may only be cleaned by Kinova personnel.
- If you notice any heavy contamination here, please contact Kinova directly.



The lifting arm should not be submerged in water or other liquids.

Preventive Maintenance of the robot

Clean and lubricate fingers every six months.



Refer all servicing to qualified service personnel. Servicing is required when the apparatus has been damaged in any way, for example if the power-supply cord or plug is damaged, if the product does not operate normally or if it has been dropped.



The product has no user serviceable parts. Do not open.

Disposal of the robot



■ The product contains parts that are deemed to be hazardous waste at the end of useful product life. For further information on recycling, contact your local recycling authority or Kinova distributor. In any case, always dispose of product via a recognized agent.

Disposal of the OLED display

Follow the rules for disposing of the OLED display according to type of user and location.

- Private households

This WEEE symbol on the product(s) and / or accompanying documents means that used electrical and electronic equipment (WEEE) should not be mixed with general household waste. For proper treatment, recovery and recycling, please take this product(s) to designated collection points where it will be accepted free of charge. Alternatively, in some countries, you may be able to return your products to your local retailer upon purchase of an equivalent new product. Disposing of this product correctly will help save valuable resources and prevent any potential negative effects on human health and the environment, which could otherwise arise from inappropriate waste handling. Please contact your local authority for further details of your nearest designated collection point. Penalties may be applicable for incorrect disposal of this waste, in accordance with your national legislation.

- Professional users in the European Union

If you wish to discard electrical and electronic equipment (EEE), please contact your dealer or supplier for further information.

- Countries outside of the European Union

This symbol is only valid in the European Union (EU). If you wish to discard this product, please contact your local authorities or dealer and ask for the correct method of disposal.

Disposal of the Lift arm

The lift arm is expected to last for the lifetime of the Kinova robotic arm that it accompanies. At the end of this period, there are two options: Continue using the device Replace the device and dispose of the old device appropriately If you wish to continue to use the lift after the normal life span of the product has passed, Kinova highly recommends that you return the device temporarily to Kinova for routine servicing to inspect the device and replace / repair any internal components that may be worn out.



If you wish to dispose of the device, note that the device contains materials that can be recycled and/or are noxious to the environment. Specialized companies can dismantle the unit and sort out these materials. When you dispose of the unit, inform yourself about local regulations concerning waste management.

Contacting support

If you need help or have any questions about this product, this guide or the information detailed within, please contact Kinova through the support page of our website at www.kinovarobotics.com/support, by phone at 1 (514) 277-3777, or by email at support@kinova.ca.

We value your comments!

To help us assist you more effectively with problem reports, please have the following information ready when contacting Kinova or distributor support:

- date and time the problem occurred
- environment where the problem occurred
- actions performed immediately before the problem occurred
- product serial number (this will allow the support agent to access the information regarding your product, such as software version, part revisions and characteristics, etc.).

If the product needs to be returned to Kinova, ensure the product is packaged in its original case for transportation.

Report all serious incidents that have occurred with the use of Jaco or any of its accessories, to Kinova or any competent authority.

For technical support issues or more information about product end of life, contact Kinova inc. at **Address:** Kinova inc., 4333 boulevard de la Grande-Allée, Boisbriand, QC, Canada, J7H 1M7.

Telephone: 1-855-6-KINOVA. **email:** support@kinova.ca.

German customers can contact our German office at **Address:** Kinova Europe GmbH, Vorderbreithenthann 150, 91555 Feuchtwangen , Deutschland. **Telephone:** +0800 5466822, **email:** support@kinovarobotics.de.

TOGETHER IN ROBOTICS



THERE IS NO NEED TOO SMALL.
NO TASK TOO GREAT.

📍 CANADA · 📍 GERMANY

EN-UG-007-r06.1-202303

KINOVA

Kinova (HQ)
Boisbriand (QC) J7H 1M7
Canada
T 1 574 277 3777
info@kinova.ca

Kinova Europe · GmbH
Assisive Technologies
91555 Feuchtwangen
Germany
T 0800 5466822 | Support@kinovarobotics.de | Assistive@kinovarobotics.de